

AIKO PV Modules Installation Manual

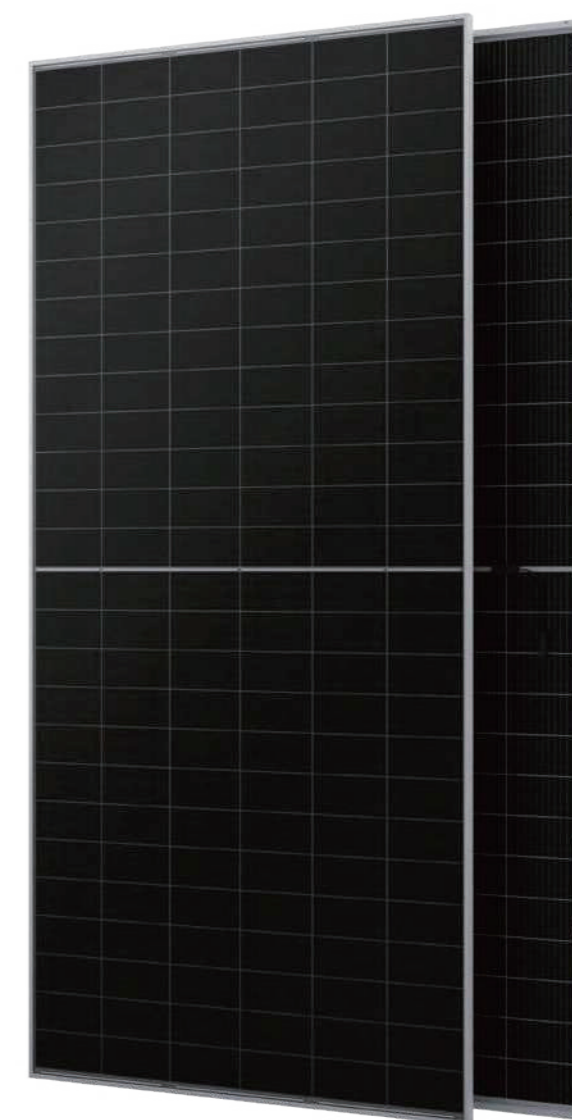

CONTENTS

AIKO PV Modules Installation Manual

AIKO reserves the right to change this Manual without prior notice.

Please check the latest version of the Installation Manual in the official website of AIKO
Website: <https://www.aikosolar.com/>

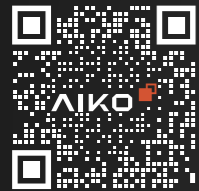

Module structure		Applicable module type
AIKO-Axxx-MAH54Dw	AIKO-Axxx-MAH54Db	Dual Glass
AIKO-Axxx-MAH72Dw	AIKO-Gxxx-MCH72Dw	
AIKO-Axxx-MAH78Dw	AIKO-Axxx-GRH66Dw	
AIKO-Axxx-MAH54Mw	AIKO-Axxx-MAH54Mb	Mono Glass
AIKO-Axxx-MAH60Mw	AIKO-Axxx-MAH60Mb	
AIKO-Axxx-MAH72Mw	AIKO-Gxxx-MCH72Mw	
AIKO-Axxx-MAH54Tm		

“ xxx ” corresponds to power ratings

Table 1: Applicable modules models



Important Safety Information

- This Installation Manual provides information regarding the installation and safe use of PV Power Generation Module (hereinafter referred to as “PV modules”) produced by Zhejiang Aiko Solar Technology Co., Ltd. (hereinafter referred to as “AIKO”). Installation and day to day maintenance of modules shall be in accordance with all safety precautions specified in this Manual and local laws.
- Installing a module system requires specialized skills and knowledge, and modules shall be installed and maintained by qualified personnel. Please read this manual carefully before installing and using this module. The installers shall be familiar with mechanical and electrical requirements of the system. Please keep this Manual for future maintenance or treatment.
- If you have any questions, please contact AIKO customer service personnel and ask them to provide further explanation.

01 Overview	P01	07 Electrical installation	P20
02 Laws and acts	P01	7.1 Electrical performance	
03 General information	P02	7.2 Cables and Connections	
3.1 Module identification		7.3 Connector	
3.2 Wiring method		08 Grounding	P22
3.3 General safety		09 Maintenance of PV modules	P24
3.4 Electrical safety		9.1 Cleaning	
3.5 Handling safety		9.2 Visual checks of the modules	
3.6 Fire safety		9.3 Checks of connectors and cables	
04 Storage and transportation instructions	P07	9.4 AIKO Technical Support	
4.1 Considerations for module turnover and handling			
4.2 Considerations for module turnover and transportation			
4.3 Considerations for module storage and placement			
05 Installation conditions	P09		
5.1 Location and working environment			
5.2 Tilt angle selection			
06 Mechanical installation	P11		
6.1 General requirements			
6.2 Mechanical installation			



Packing List

组件装箱清单

Pallet No. 托盘号	A223711001		Module Power 组件功率	625 W	
			Qty 数量	36 PCS	
Product No. 产品编码	300100000125		Color Code 膜色	S2	
Module Type 组件型号	AIKO-G625-MCH72Dw	Remark: 备注:	Sirius/Polaris		
Product Description 产品描述	72 Dual-glass White/2382×1134×30mm/+350/-280mm/Compatible MC4-AK 72双玻白底白边/2382×1134×30mm/+350mm/-280mm/MC4兼容-AK				
N.W 净重	1188.0 KG	EAN: 6 976601 551163			
G.W 毛重	1248.0KG				
Package Size 包装尺寸	2390*1130*1260mm				
NO.	Serial Number	NO.	Serial Number	NO.	Serial Number
1		2		3	
4		5		6	
7		8		9	
10		11		12	
13		14		15	
16		17		18	
19		20		21	
22		23		24	
25		26		27	
28		29		30	
31		32		33	
34		35		36	
37		38		39	
Made in China 中国制造					

3.2 Wiring method

The junction box of AIKO PV modules is located in the middle position. Please refer to the table below for how to connect AIKO PV modules in series.

Position of junction box	Module mounting type	Connection diagram
	Mounting on the long side, single row	<p>Horizontally adjacent modules are directly connected at the shortest distance or, if the wire is too long, by placing the wire into the secondary beam.</p>
	Mounting on the long side, double rows	<ol style="list-style-type: none"> Horizontally adjacent modules are directly connected at the shortest distance or, if the wire is too long, by placing the wire into the secondary beam; Connections between adjacent rows of modules shall be designed and installed by considering the opposite polarity on the same side as shown below. Adjacent modules are side connected by routing the wire through a duct instead of using an uncovered wire.
	Mounting on the short side, single row	<p>In vertical installation, connections between vertically adjacent modules are designed and installed with opposite polarities between adjacent modules as shown and the extension line can be placed into the secondary beam.</p>
	Mounting on the short side, multiple rows	<ol style="list-style-type: none"> Vertically adjacent modules as shown below are connected at the shortest distance; Connections between adjacent columns of modules shall be designed and installed by considering the opposite polarity on the same side as shown below. Adjacent modules may be side connected by placing the wire into the secondary beam.

Table 2: Connection diagram as per mounting type

3.3 General safety

AIKO PV modules are designed to operate in application according to IEC standards IEC-61215 and IEC-61730. The module can be used in systems with DC voltage greater than 50V or power greater than 240W that may be accessible to the public. Dual glass PV modules are designed with safety Class II and fire class rating A; Mono glass PV modules are designed with safety Class II and fire class rating C.

- Before to handle and install AIKO PV modules, read carefully and understand this Installation Manual. If you need any explanation, contact AIKO (aikosolar.com).
- Regardless of whether the module is electrically connected or not, always use appropriate protections such as insulated tools, safety helmets, insulating gloves, safety belts and safety insulating shoes when handling the Pv module whether it is or not connected to the system. Please use the appropriate electrical safety tools when you need to install ground,connect, clean or handle the module.
- PV modules generate DC electrical energy when exposed to sunlight or other light source. Direct contact with modules should be avoided, causing electric shock.
- Observed local laws and regulations for module installation and obtain a building license or other qualifications where necessary.
- PV modules shall be installed by qualified personnel who have specialized skills and knowledge and are familiar with the mechanical and electrical requirements of the system. Potentially harmful risks during installation, including electrical shock, shall be identified in advance.Installers should be equipped with appropriate safety and personal protective equipment and use them correctly.
- Rooftop systems can only be installed on the roofs which have passed the evaluation of construction experts with formal, full structural analysis results. The roof also shall be proven to be able to withstand the weight of the related photovoltaic system.
- Observed the safety regulations for all mounting components. For example, wires and cables,connectors, Charge controller, inverters and batteries. Only use equipment, connectors, wires,and brackets that match the solar power system. If the PV system is equipped with a battery,the advice of the battery manufacturer should be followed.
- Artificially concentrated sunlight shall not be directed onto the PV module.



3.4 Electrical safety

Please strictly follow the electrical safety precautions below to avoid any form of electrical safety accident.

- PV modules can generate DC voltage >30V under standard temperature condition (STC), take care to avoid direct contact. When installing PV modules, wear protective helmets, insulating gloves, and rubber shoes. Do not install PV modules without security precautions.
- Do not drill holes in the frame, this action may cause PV module insulation failure
- Do not make electrical connection by means other than connectors.
- Broken PV modules have the risk of electric shock and fire that must be replaced immediately.
- PV Module must be installed when it is electrically safe.
- Avoid unnecessary touching PV modules as the surface and frame of the PV modules may be hot and there is a risk of burns or electric shock. The voltage connected in series of the PV modules must not exceed the maximum withstand voltage value.
- Do not connect or disconnect the PV module when there is a current leakage of module or when there is an external current present. Please disconnect the faulty PV modules with safety protection.

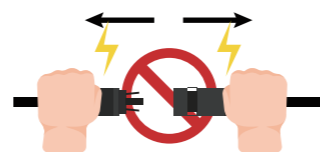
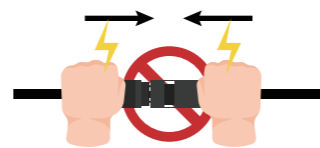

3.5 Handling safety

- Select appropriate, suitable, and smooth transportation methods to avoid damage to component packaging.
- Standing, stepping, sitting, walking or jumping directly on the PV module package or PV module is prohibited.



- Do not place heavy objects on the PV module; Do not place the module on a sharp surface.Do not collide or distort the edges of the components.



- Do not connect the positive and negative anode cables of the same PV module together.
- Do not open the carton box before the PV modules arrive at the location, keep the packing box in a ventilated, dry environment.
- During the transportation, please refers to Chapter 4 - Storage and Transportation instructions. Any inappropriate handling and storage can result in breakage of glass or loss of electrical property, and consequently loss the use value of PV modules.
- Take carefully by installing PV modules. In any case, it is forbidden to lift the PV module by lifting the junction box or cable. At least two or more than two operators must hold the edges of the PV module with both hands.
- Do not try to dismantle the PV module or remove any nameplates or components of PV modules.
- Do not apply paint or other adhesives to PV module top surface.
- Do not damage or scratch the glass on front side and back side of PV module.
- Do not drill holes on the frame of PV module, which may reduce frame loading capacity and lead to frame corrosion and invalidation of the limited warranty provided for customers.
- Do not scratch anodized coating of aluminum alloy frame except for grounding connection. Scratch may lead to frame corrosion and reduce frame loading capacity and long-term reliability.
- Do not repair or modify the PV module on your own.

3.6 Fire safety

- Please refer to local laws and regulations before installing any PV modules and observe their building fire safety requirements.
- Rooftop installations shall be placed over fire resistant roof coverings appropriate for this rating, and adequate ventilation shall be provided between the back glass and the mounting surface. The roof structure and PV module mounting method will affect the fire safety performance of the building. Inappropriate installation can lead to fire risks.
- To guarantee roof fire rating, the distance between PV module frame and roof surface must be greater than 10 cm.
- Please use the appropriate PV module accessories, e.g., fuses, circuit breakers and ground connectors, according to local laws and regulations.
- Please do not apply PV modules in where exposed inflammable gases are nearby.

04 Storage and Transportation Instructions

4.1 Considerations for PV Module Turnover and Handling

Upon arrival of the PV modules, please check whether the carton box is in good condition, and check whether the PV module type and quantity on the outer packaging are consistent with the delivery order. If anything wrong is observed, please contact AIKO logistics and sales staff immediately.

1. Crane unloading:

Crane operations require dedicated personnel to command and certified personnel to work; Before lifting the goods, conduct a visual inspection of the box and pallet, and check whether the lifting straps are firm and secure.

When unloading PV modules by crane, please choose and use specialized tooling according to the weight and size of the pallet. The center of gravity of the module should be at the top of the box. Please adjust the position of the sling to keep the modules steady.

To ensure the safety of the PV module, wooden sticks, boards or other fixtures of the same width as the outer packing cases should be used on the upper part of the box to prevent the sling from squeezing the pallet and damaging the PV modules.

Please operate the spreader at a constant speed, when the lifting is close to the ground, place the box gently in a relatively flat ground.



Do not unload PV modules under the weather conditions of wind more than 6 class (in Beaufort scale).

2. Forklift unloading:

The loading dock should be as the same height as the underside of the carrier.

Driving speed control $\leq 3\text{km/h}$, forklift speed control $\leq 1\text{km/h}$, to avoid emergency stop, rapid start, bumpy vibration, and sharp object collision with components.

The height of the forklift shelf baffle should be $\geq 1200\text{mm}$, and a buffer pad should be installed on the front arm of the forklift to avoid direct contact with the components; The maximum number of forks per shipment is 1 stack.

Forklift operators must hold professional operating certificates. If the packaging box obstructs the forklift driver's line of sight it is recommended to reverse the forklift during transportation and arrange for a dedicated person to supervise and command to ensure that the forks do not exceed the components, preventing accidents that may cause personal injury or damage to components due to the dropping of packaging boxes.

After transportation to the installation site, please choose a hard ground for placement as much as possible.



4.2 Considerations for PV Module Turnover and Transportation

- When using a forklift to transport components, please ensure that the fork length of the forklift meets the requirements. It is recommended that the thickness of the forklift teeth be less than 80mm, and the length of the 3/4 pallet be less than the fork length and the pallet length. When forking, the fork should be tightly attached to the ground, and the distance between the forks should be adjusted to a suitable distance to avoid uneven force that may cause the components to tilt.

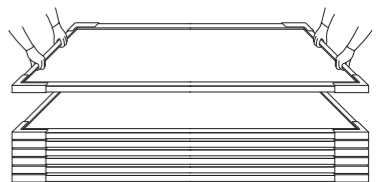

- During the transportation of components, the component pallets shall be placed closely, and the gap between the component packaging box and the front and rear of the vehicle and container shall be filled with foam to avoid collision and damage to the components.
- If using box trucks or other types of vehicles for transportation, please pay attention to using carriages with guardrails. The height of the guardrails should not be less than 2/3 of the height of the components, and fastening straps should be used to fix the components to the carriages.
- When the components are to be transported at the project site, the transportation route should be chosen on a smooth road surface to avoid damage or hidden cracks caused by bumps, collisions, squeezing, tilting, etc.
- Before unpacking, conduct an external packaging inspection, use a utility knife to remove the packing tape, prohibit violent disassembly, and prohibit sharp objects from contacting the components.
- When opening the carton box, please place the PV modules to be unpacked at a distance of 20-30cm from the wall or another row of PV modules, and then remove the row. After removing the cable tie of the fixed PV modules, slowly lean the PV modules against the wall or another row of PV modules to prevent them from falling.
- Please handle the installation PV modules gently during transportation. Do not lift the PV modules by pulling the junction box or cables under any circumstances. Two or more people must hold the edges of the PV modules with both hands.

4.3 Considerations for PV Module Storage and Placement

- Please store the packing box of PV modules in a clean, dry and flat place with relative humidity below 85%RH. The storage temperature should be between $-20\text{ }^{\circ}\text{C}$ and $50\text{ }^{\circ}\text{C}$. When storing PV modules for a long time, do not place the two boxes of PV modules on top of each other. Components should be placed neatly with a safe distance, and the distance between boxes should be greater than 30cm.
- In any circumstances, keep the junction box and cables of the PV modules clean and dry.
- Store PV modules in a ventilated, rainproof, dry place. If placed outdoor, please fully cover the PV modules and pallets with a rain protection and take moisture-proof measures on pallets and cartons to prevent collapse and moisture ingress.
- For the storage of scattered PV modules, please stack the vertical PV modules flat on the empty torr. The first PV module should be placed with the glass side up, and the following ones placed with the glass side down. (A maximum of 22 modules can be stacked for 54-cell types and 60-cell types, and 16 modules for 72-cell/66-cell and 78-cell types).
- For long-term storage, do not remove the original package and keep the wrapping film and carton box in a good condition. It's recommended to place PV modules in a standard warehouse for long-term storage and conduct regular inspections. Once there is an abnormal tilt, please take enforcement measures in time.

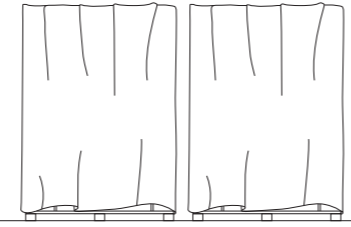

- PV modules shall be installed in a well-ventilated position to ensure adequate air circulation on the back and sides of the PV module and allow immediate dissipation of heat produced during PV module operation, poor heat dissipation of the PV modules will decrease the output power and affect the overall power output of PV modules.
- When PV modules suffer high wind or snow pressure, supports and fixings shall be designed according to local design standards to keep external loads within the maximum mechanical strength that PV modules can withstand.
- In areas (coastal areas, factories, volcanic areas, farmlands) exposed to salt fog, sulfide or ammonia gas, corrosion can occur at the connection between the PV module and the racking or at the ground connection. Anti-corrosive materials (e.g., stainless steel or aluminum materials) must be used in contact with PV modules and the mounting position must be protected against rust (Except for products that can be used in offshore or salt-affected areas, as confirmed and supplied by AIKO).
- After installing PV modules, measures such as grounding must be taken to ensure that the PV modules are protected against lightning strikes.



05 Installation Conditions

5.1 Location and working environment

- The component is not suitable for the space environment.
- The component must be installed on a suitable ground or building and cannot be installed on any type of movable vehicle.
- PV modules are recommended to be installed in a $-20\text{ }^{\circ}\text{C}$ to $40\text{ }^{\circ}\text{C}$ environments, with a module operating temperature of $-40\text{ }^{\circ}\text{C}$ to $85\text{ }^{\circ}\text{C}$, T98 rating of $70\text{ }^{\circ}\text{C}$ and a humidity less than 85%RH.
- Do not install PV modules in locations or areas where there is a risk of flooding, and do not install or place PV modules near open flame or flammable materials.
- PV modules can be installed at a distance of 50m to 500m away from the seashore. In the case when the PV modules are installed within 50m to 500m distance from the seashore, the frame and related components need to be treated with anti-corrosion (Except for products that can be used in offshore or salt-affected areas, as confirmed and supplied by AIKO).
- For rooftop installations, leave a safe working area between the edge of the roof and the external edge of the PV module array.
- For rooftop installations, check the roof loads and make a construction organization plan to meet the applicable standards.
- Ensure PV module is positioned to receive adequate sunlight and avoid shading the PV module surfaces in part or in whole (by trees, buildings etc.).

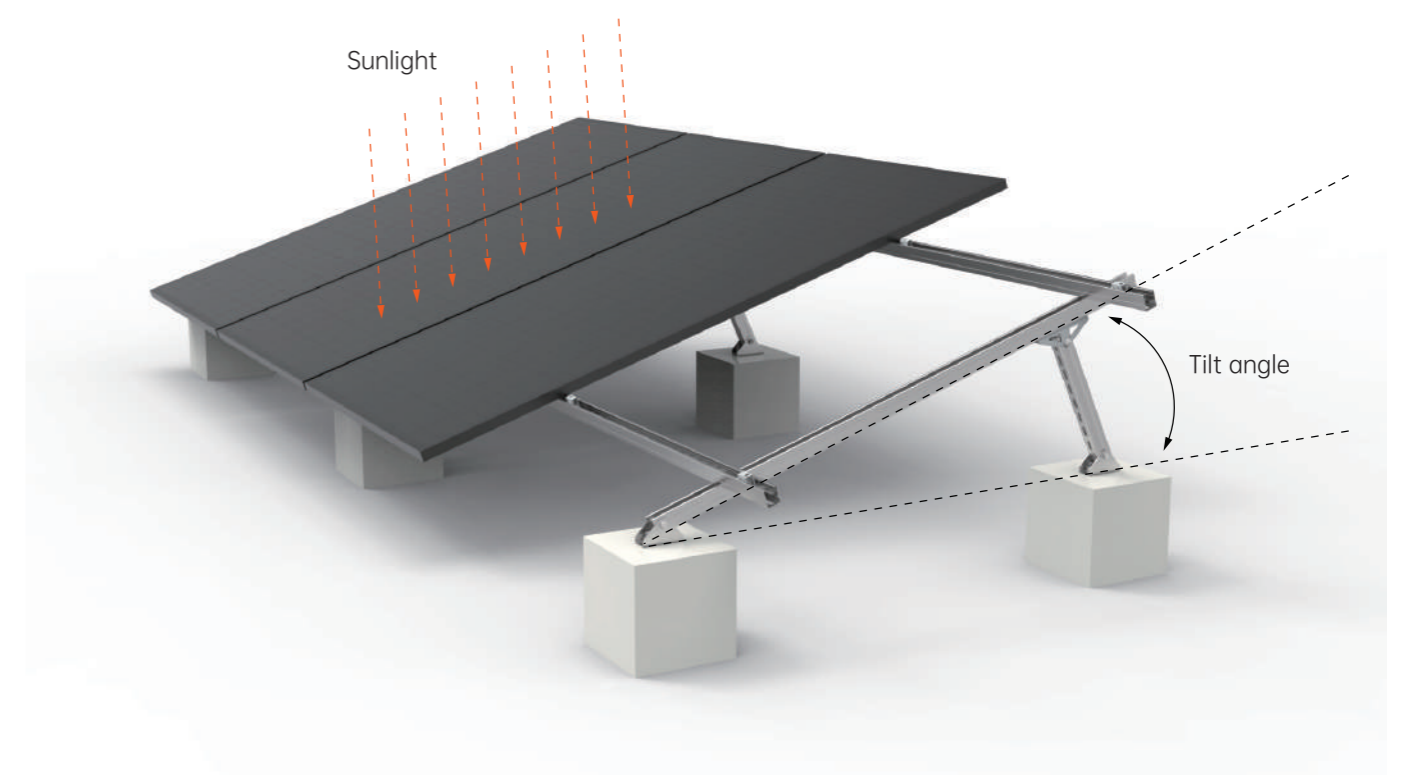

5.2 Tilt angle selection

Tilt angle of PV module is the angle between the PV module and the horizontal ground. Different projects should choose different installation inclination angles according to local conditions.

- All PV modules in the same array should be same orientation and angle. Different orientations and angles will result in different total solar irradiance absorbed by PV modules, leading to output mismatch that degrades system operating efficiency.
- In order to achieve the maximum annual generating capacity, the optimal orientation and inclination of PV modules in the installed area should be selected. When the surface of the PV module is perpendicular to sunlight, the output power reaches the maximum output value. AIKO recommend the installation angle should not less than 10°.
- The optimal tilt angle of PV arrays should be designed by taking into account the multi-year average monthly irradiance, direct irradiance, scattering irradiance, wind speed and other climate conditions at the location. PV modules should be tilted at an angle to receive the maximal annual irradiance. Angles shall be selected by considering natural conditions such as local wind load, snow load and avoidance of water and dust collection on module surfaces.

For details on the optimal tilt angle for installation, refer to consult a reliable local solar system installation company.

06 Mechanical Installation

6.1 General Requirements

- Make sure that the PV modules are properly installed and the mounting structure are adequately fastened. PV module mounting system shall be constructed of anticorrosive, ultraviolet resistant materials.
- Installation bracket system shall be tested and inspected by the third-party testing institution with static mechanical analysis capacity in accordance with local national standards or international standards.
- In regions with heavy snowfall in winter, adjust the height of the mounting system so that the lower edge of the PV module is not covered by snow. In addition, ensure the lower part of PV module is not in the shadow of plants, trees.
- For rooftop installations, the minimum gap between the PV module frame and the roof shall be 10cm which is good for air circulation to achieve better performance of PV module.
- The module frames can encounter thermal expansion and cold contraction. There will be a certain amount of bending deformation at different temperatures, which will not affect the performance and reliability of the module. The minimum mounting distance between adjacent PV modules is 10mm. If there are special requirements, please contact AIKO for more details on installation methods.
- The minimum mounting distance between adjacent PV modules is 10 mm.
- Make sure that backside of PV modules will not be in contact with bracket or building structures that can pierce into the inside of the PV modules, especially when the PV module surface is imposed by pressure.

- Maximum static load of the PV module is downforce 5400 Pa and uplift force 2400 Pa, which can vary from different mounting methods of the modules (please refer to the following installation guidance), the described load in this manual is for the test load.
- The PV module loads described herein are test values. According to IEC 61215-2021 installation requirements, when computing the corresponding maximum design load, it is necessary to divide by at least 1.5 times the safety factor in compliance with the local laws or regulations.
- In additions, project design loads must be based on project location, climate, mounting structure and applicable standards. Design loads are determined by bracket suppliers and professional engineering and technical personnel. please observe both the local laws and regulations and the instructions of structural engineers.

6.2 Mechanical Installation of PV Modules

PV modules can be connected to the racking system using pressure clamps and bolts. PV Modules must be mounted as recommended and illustrated below. Other mounting configurations may be used provided that consultation is made with, and prior written consent is received from AIKO. Failure to do so will invalidate our warranty.

6.2.1 PV Module Installation Method: Mounting pressure Clamps

Specialized pressure clamps are used to mount modules as shown below.

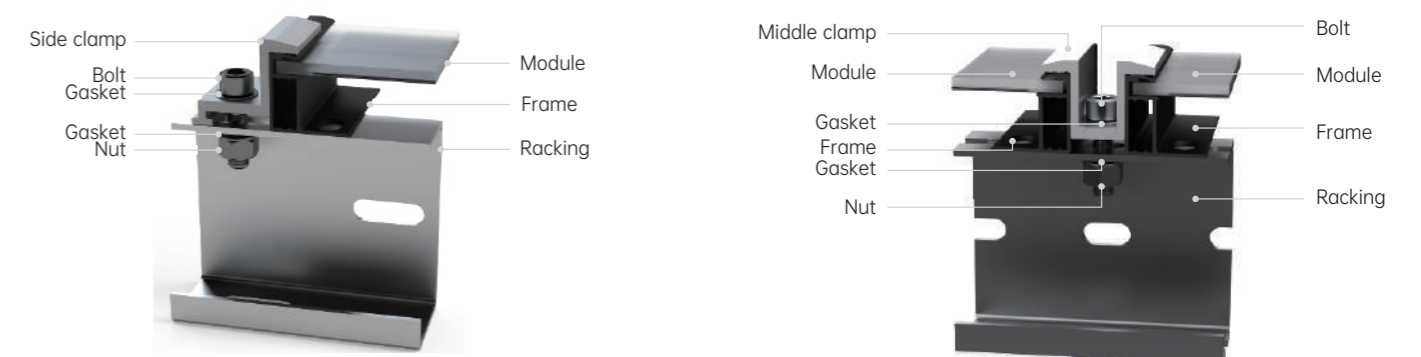

- Under no circumstances should the clamp touch the glass or deform the frame.
- Be sure to avoid shadowing effect from the pressure clamp.
- When installing the modules, be cautious not to block the drain hole of the frame.
- Pay attention to the matching of the height of the frame with the pressure clamp.
- Be sure that pressure clamps will not fail due to deformation or corrosion while the entire PV module is under load. Pressure clamps of material 6005-T6 are recommended. The length should be $\geq 50\text{mm}$ and the thickness should be $\geq 4\text{mm}$. The overlapped distance between the pressure clamps and the module frame should be at least 10mm, but no more than 12mm.
- Clamp positions are of crucial importance for the reliability of the installation. The clamp centerlines must only be positioned within the ranges indicated in table below, depending on the configuration and load.

- When choosing clamp-mounting, please be sure to use at least four clamps on each PV module. Depending on the local wind and snow loads, if excessive pressure load is expected, at least six clamps should be required to ensure the PV module can bear the load (more details, please contact AIKO technical personnel).
- Do not drill additional holes or modify the PV module frame. Doing so will void the PV module's warranty.
- Use appropriate corrosion-proof fastening materials. All mounting hardware (bolts, spring washers, flat washers, nuts) should be hot dip galvanized or stainless steel. Install and tighten the PV module clamps to the mounting rails using the torque stated by the mounting hardware manufacturer.
- M8 bolt tightening torques must be within 16~20Nm and M6 bolt tightening torques must be within 8~12Nm, respectively depending on bolt classes. For the bolt grade, the technical guidelines from the fastener suppliers should be followed. Different recommendations from specific clamping hardware suppliers should prevail.

6.2.2 PV Module Installation Method: Bolts Mounting

Using bolts to secure the PV module on the bracket through the mounting holes at the back of PV module's frame. PV modules come standard with 4 or 8 mounting holes, matching M8 or M6 bolts, as figure below:

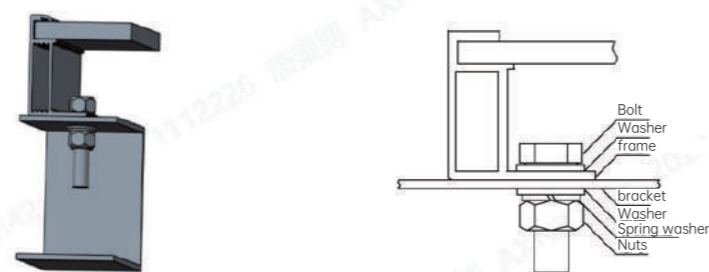

Module Mounting Holes







Accessories	Model	Accessories	Model
Bolt	M8	Bolt	M6
Spring washer	8	Spring washer	6
Washer	2 pcs, thickness 1.7mm and outside diameters = 16mm	Washer	2 pcs, thickness 1.7mm and outside diameters = 12-16mm
Nuts	M8	Nuts	M6

- It is important to ensure the bolts do not fail due to deformation or corrosion during the overall load of the PV module.
- AIKO recommend the thickness of washer should $\geq 1.7\text{mm}$ and use M8 and M6 bolt tightening torques must be within 16~20Nm and 8~12Nm, respectively, depending on bolt classes.
- For the bolt grade, the technical guidelines from the fastener suppliers should be followed. Different recommendations from specific clamping hardware suppliers should prevail.

PV Model	mounting holes diagram
54/60	
78	
72	

6.2.3 Installation and Mechanical Load of Mono Glass Module

Mono glass modules can be mounted by bolts or clamps. The mounting method and maximum test load are shown as follow (The unit of distance and length in the table below is millimeter (mm), and the unit of pressure is Pascal (Pa)).

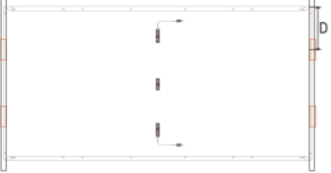
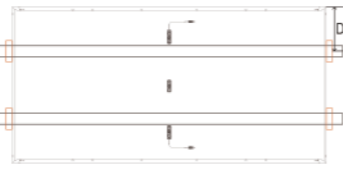
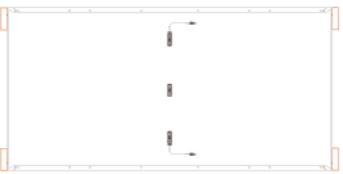
 <p>Outer four-hole bolts mounting Mounting rails cross the long frame. (Method 1)</p>	 <p>Inner four-hole bolts mounting Mounting rails cross the long frame. (Method 2)</p>
 <p>Outer four-hole bolts mounting Mounting rails run parallel to the long side. (Method 3)</p>	 <p>Inner four-hole bolts mounting Mounting rails run parallel to the long side. (Method 4)</p>
 <p>Clamps mounting on the long side Mounting rails run parallel to the long side frame. (Method 5)</p>	 <p>Clamps mounting on the long side Mounting rails cross the long frame. (Method 6)</p>
 <p>Clamps mounting on the short side Mounting rails run parallel to the short frame. (Method 7)</p>	 <p>Clamps mounting on the short side Mounting rails cross the short frame. (Method 8)</p>
 <p>Clamps are mounted at the corners of short frame. (Method 9)</p>	

Mechanical loads information of 54-cells and 60-cells with framed mono glass modules

Module Type	Module Size L*W*H (mm)	Bolts Mounting		Clamps Mounting				
		Method 1	Method 2	Method 5	Method 6	Method 7	Method 8	Method 9
AIKO-Axxx-MAH54Mw AIKO-Axxx-MAH54Mb	1722*1134*30	+2400/-2400 Pa	+5400/-2400 Pa	/	+5400/-2400 Pa; Clamps Mounting range : 295-395mm	+1600/-1600 Pa; Clamps Mounting range : 100-240mm	/	/
AIKO-Axxx-MAH54Mw AIKO-Axxx-MAH54Mb	1757*1134*30	+2400/-2400 Pa	+5400/-2400 Pa	+2400/-2400 Pa; Clamps Mounting range : 350-450mm	+5400/-2400 Pa; Clamps Mounting range : 310-410mm	+1600/-1600 Pa; Clamps Mounting range : 100-240mm	+2400/-1600 Pa; Clamps Mounting range : 100-240mm	+1600/-1600 Pa; Clamps Mounting range :s=0
AIKO-Axxx-MAH54Tm	1762*1134*30	/	/	/	+3600/-2400 Pa; Clamps Mounting range : 400-500mm	/	/	/
AIKO-Axxx-MAH60Mw AIKO-Axxx-MAH60Mb	1954*1134*30	+3600/-2400 Pa	+5400/-2400 Pa	/	+5400/-2400 Pa; Clamps Mounting range : 345-415mm	/	/	/

Mechanical loads information of 72-cells with framed mono glass modules



Module Type	Module Size L*W*H(mm)	Bolts Mounting	Clamps Mounting
		Method 1	Method 6
AIKO-Axxx-MAH72Mw	2278*1134*30	+5400/-2400Pa	+5400/-2400Pa; Clamps Mounting range :450-500mm
AIKO-Axxx-MAH72Mw	2323*1134*30/33	+5400/-2400Pa	+5400/-2400Pa; Clamps Mounting range :470-520mm
AIKO-Gxxx-MCH72Mw	2382*1134*33	+5400/-2400Pa	+5400/-2400Pa; Clamps Mounting range :420-470mm
AIKO-Gxxx-MCH72Mw	2382*1134*30	+5400/-2400Pa	+5400/-2400Pa; Clamps Mounting range :500-550mm

Note:

- The above data is based on the static load requirements of IEC61215 standard (Tested by AIKO or thirdparty certification institution), please contact AIKO for more details on other installation methods and load capacity not listed..
- "/" identifies that there is no such installation.
- Bolt mounting installation is not intended for AIKO-Axxx-MAH54Tm

6.2.4 Installation and Mechanical Load of Dual Glass Module

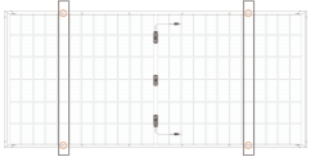
Dual glass modules can be mounted by bolts or clamps. The mounting method and maximum test load are shown as follow (The unit of distance and length in the table below is millimeter (mm), and the unit of pressure is Pascal (Pa)).

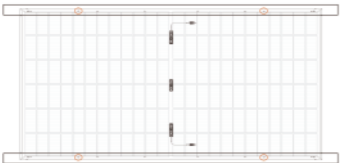
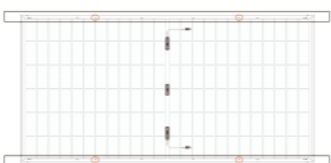
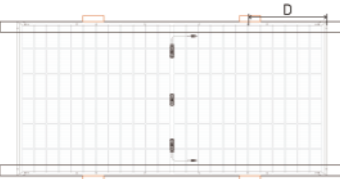
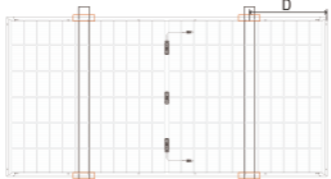
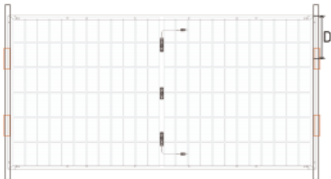
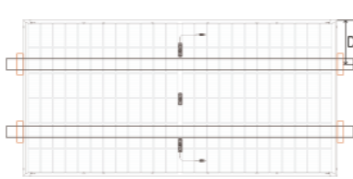
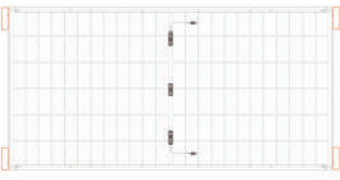
 <p>Outer four-hole bolts mounting Mounting rails cross the long frame. (Method 1)</p>	 <p>Inner four-hole bolts mounting Mounting rails cross the long frame. (Method 2)</p>
 <p>Outer four-hole bolts mounting Mounting rails run parallel to the long side. (Method 3)</p>	 <p>Inner four-hole bolts mounting Mounting rails run parallel to the long side. (Method 4)</p>
 <p>Clamps mounting on the long side Mounting rails run parallel to the long side frame. (Method 5)</p>	 <p>Clamps mounting on the long side Mounting rails cross the long frame. (Method 6)</p>
 <p>Clamps mounting on the short side Mounting rails run parallel to the short frame. (Method 7)</p>	 <p>Clamps mounting on the short side Mounting rails cross the short frame. (Method 8)</p>
 <p>Clamps are mounted at the corners of short frame. (Method 9)</p>	

Mechanical loads information of 54-cells and 60-cells with framed dual glass modules

Module Type	Module Size L*W*H (mm)	Bolts Mounting		Clamps Mounting				
		Method 1	Method 2	Method 5	Method 6	Method 7	Method 8	Method 9
AIKO-Axxx-MAH54Db	1722*1134*30	+2400/-2400 Pa	+5400/-2400 Pa	/	+5400/-2400 Pa; Clamps Mounting range : 295-395mm	+1600/-1600 Pa; Clamps Mounting range : 100-240mm	/	/
AIKO-Axxx-MAH54Db AIKO-Axxx-MAH54Dw	1757*1134*30	+2400/-2400 Pa	+5400/-2400 Pa	+1600/-1600 Pa; Clamps Mounting range : 150-600mm	+5400/-2400 Pa; Clamps Mounting range : 295-395mm +2400/-2400 Pa; Clamps Mounting range : 150-600mm	+1600/-1600 Pa; Clamps Mounting range : 100-240mm	+2400/-1600 Pa; Clamps Mounting range : 100-240mm	+1600/-1600 Pa; Clamps Mounting range :s=0

Mechanical loads information of 72-cells and 78-cells with framed dual glass modules

Module Type	Module Size L*W*H (mm)	Bolts Mounting			Clamps Mounting	
		Method 1	Method 2	Method 4	Method 5	Method 6
AIKO-Axxx-MAH72Dw	2278*1134*30	+5400/-2400Pa	/	/	/	+5400/-2400Pa; Clamps Mounting range :380-480mm
AIKO-Axxx-MAH72Dw	2323*1134*30	+5400/-2400Pa	/	/	/	+5400/-2400Pa; Clamps Mounting range :500-550mm
AIKO-Axxx-MAH78Dw	2465*1134*30	/	+5400/-2400Pa	/	/	+5400/-2400Pa; Clamps Mounting range :550-650mm
AIKO-Gxxx-MCH72Dw AIKO-Axxx-GRH66Dw	2382*1134*30	+5400/-2400Pa	/	+2400/-2400Pa	+2400/-2400Pa; Clamps Mounting range :500-600mm	+5400/-2400Pa; Clamps Mounting range :500-600mm

Note:

1. The above data is based on the static load requirements of IEC61215 standard (Tested by Alko or thirdparty certification institution), please contact Alko for more details on other installation methods and load capacity not listed..

2. "/" identifies that there is no such installation.

6.2.5 PV Module Installation Method: Single-axis Tracking System Installation

AIKO 72 type modules come with standard four mounting holes matching M8 bolts (790mm and 1400mm mounting holes); 72 type modules have an additional four mounting holes matching M6 bolts (400mm mounting holes), used for matching Tracking system product such as NEXTracker. Using bolt to install the PV module on the bracket through the mounting hole at the back of the PV module's frame. Installation details as below:

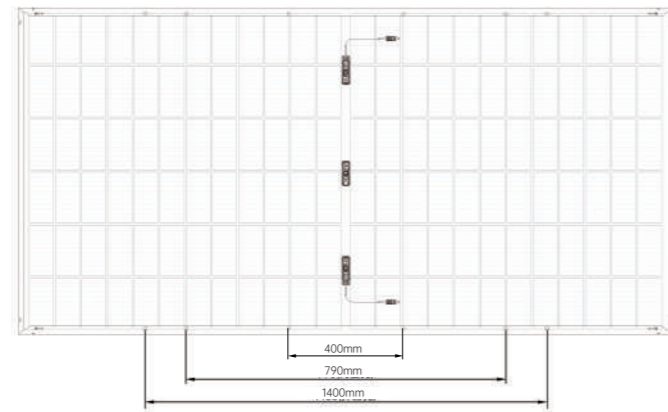

Note that: M8 bolt tightening torques must be within 16~20Nm and M6 bolt tightening torques must be within 8~12Nm, respectively, depending on bolt classes. For the bolt grade, the technical guidelines from the fastener suppliers should be followed. Different recommendations from specific clamping hardware suppliers should prevail.

Module Type	Module Size L*W*H(mm)	Mounting Hardware	Test Load (Pa)
AIKO-Axxx-MAH72Dw	2278*1134*30	400mm mounting holes	+2100/-2100
		790mm mounting holes	+2600/-2400
		400mm+1400mm mounting holes	+2600/-2400
		790mm+1400mm mounting holes	+3000/-2400
AIKO-Gxxx-MCH72Dw AIKO-Axxx-GRH66Dw	2382*1134*30	400mm mounting holes	+1800/-1800
		790mm mounting holes	+2500/-2400
		400mm+1400mm mounting holes	/
		790mm+1400mm mounting holes	/

Note:

- The above data is based on the static load requirements of IEC61215 standard (Tested by Alko or thirdparty certification institution), please contact Alko for more details on other installation methods and load capacity not listed..
- "/" identifies that there is no such installation.

07 Electrical Installation

7.1 Electrical performance

There are tolerances ($\pm 3\%$) between the rated values of the electrical performance under STC and measured values. Including I_{sc} , V_{oc} and P_{max} under STC (1000 W/m² Irradiance, a cell temperature of 25 °C and an AM1.5).

When PV modules are in series connection, the string voltage is sum of every individual PV module in one string. When PV modules are in parallel connection, the current is sum of the individual PV modules as shown in below. PV modules with different electric performance models cannot be connected in the same string.

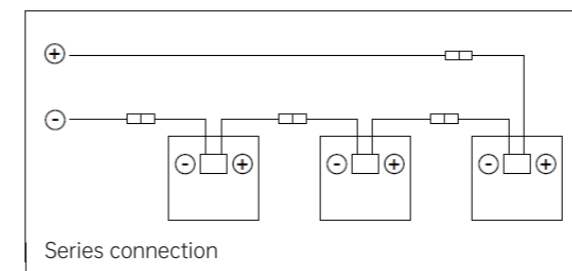

- Overcurrent protective device
- Diode
- Connector

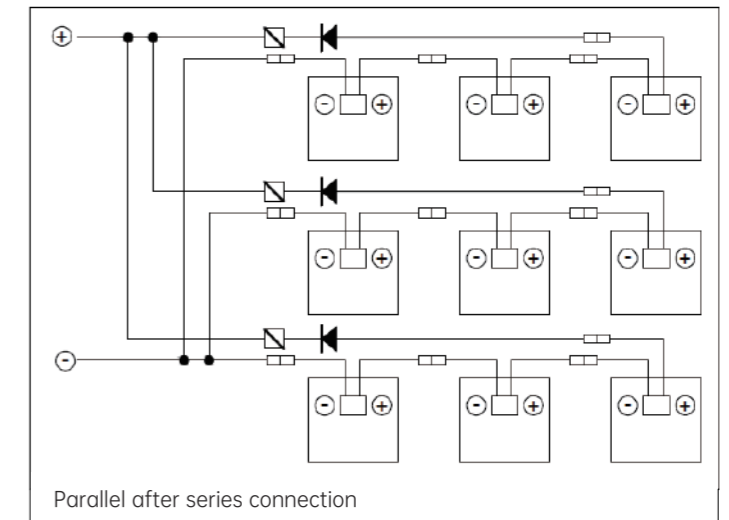

If the PV module is passed through by a reverse current greater than the maximum fuse current of the PV module, the PV module shall be protected with an over current protector of the same specification. If more than two strings are connected in parallel, each PV module string shall be protected with an over current protector as shown above.

The string voltage must not exceed the maximum voltage that the system can withstand or the maximum input power of the inverter or other electrical devices installed in the system. To ensure this, the open circuit voltage of the array shall be calculated at the minimum expected ambient temperature at that location. The following formula may be used:

$$\text{Maximum system voltage} \geq N \times V_{oc} \times [1 + \beta \times (T_{min} - 25)]$$

Where:

- N — number of modules connected in series
- V_{oc} — open circuit voltage of each module (refer to product nameplate or specification) [V]
- β — temperature coefficient of open circuit voltage for the PV module (refer to the specification) [°C⁻¹]
- T_{min} — lowest ambient temperature [°C]

7.2 Cables and Connections

PV module's junction boxes with the IP68 protective level and composed of connected cables and IP68 connectors. The PV module has a positive and a negative PV connector connected into the junction box and a plug-and-play connector connected at the other end. Using the positive connector of the module to connect the negative connector of the adjacent module connects the two modules in series. Use specialized solar cables and appropriate connectors according to local electrical and installation standards, codes and regulations at the location, and ensure that the electrical and mechanical properties of the cables are good. Electrical connections shall comply with local electrical regulations.

AIKO PV modules use specialized PV cables which have a cross sectional area of 4 mm² and are ultraviolet resistant. AIKO recommends that all cables are run in appropriate conduits and sited away from areas prone to water collection, AIKO recommend use copper cables with a minimum cross sectional area of 4mm² which are rated for 90°C and are UV resistant shall be used as PV connecting lines. The minimum bending radius of the cable is 43mm.

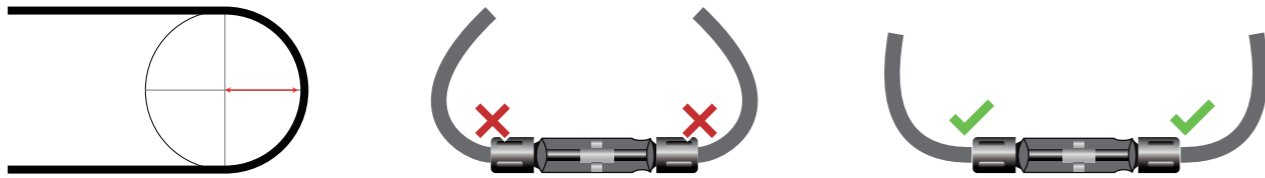

7.3 Connector

Take care to keep the connectors dry and clean. Make sure that the connector nuts are tightened before making any connection. Do not connect while the connectors are wet or otherwise abnormal. As connectors provide IP68 protection only when the positive and negative poles are fully mated, please connect PV modules as soon as possible after installation or take proper steps to prevent water vapor and dust from coming into the connector.

Avoid exposing the connector to direct sunlight and water. Avoid exposing the connector directly to ground surface or roof.

Make sure that all electrical connections are secure. Incorrect connection can result in electrical arcing and shocks.



08 Grounding

PV modules are designed with an anodized anticorrosive aluminum alloy frame as a rigid support. PV module frames must be grounded to ensure safe use and protect the PV module against lightning and electrostatic damage. Grounding must be made with the grounding device in full contact with the interior of the aluminum alloy and penetrating the oxide film on the frame surface.

Grounding devices include grounding screws, flat washers, puncture gaskets and grounding wires. All these items shall be constructed of stainless steel except grounding wires. Grounding conductors or wires shall be copper wires. Grounding conductors shall be connected to the ground through an appropriate grounding electrode. Third-party grounding devices meeting local electrical installation standards at the location may be used for grounding AIKO PV modules. Grounding device shall be installed according to the operation manual provided by the manufacturer.

Following is the recommended grounding method:

There are $\phi 4.2$ mm grounding holes on surface C of the PV module frame. Use a separate grounding wire and accessories to connect the aluminum alloy frame of PV modules and connect the grounding wire to the ground. We recommend using M4×12 mm grounding bolts accompanied by M4 nuts, star washers and flat washers.

We recommend torquing grounding bolts to 3~7 Nm and using 4 mm² copper wires as grounding wires.

Unused PV module mounting holes on the frame may also be used for grounding purposes.

Connection mode: The star washer, flat washer, and ground wire are placed in sequence, threaded through the ground hole using screws, and tightened to secure the adjacent PV modules.

Components

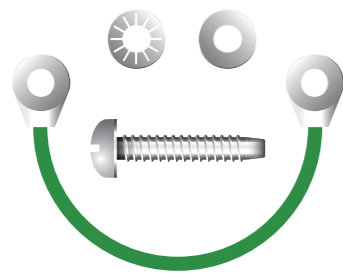

Sketch map

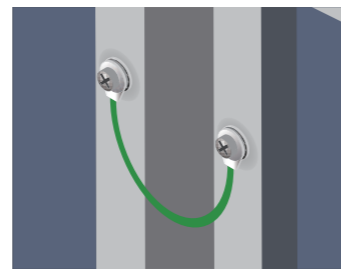

We recommend using the following method to ground correctly, as shown in the figure.

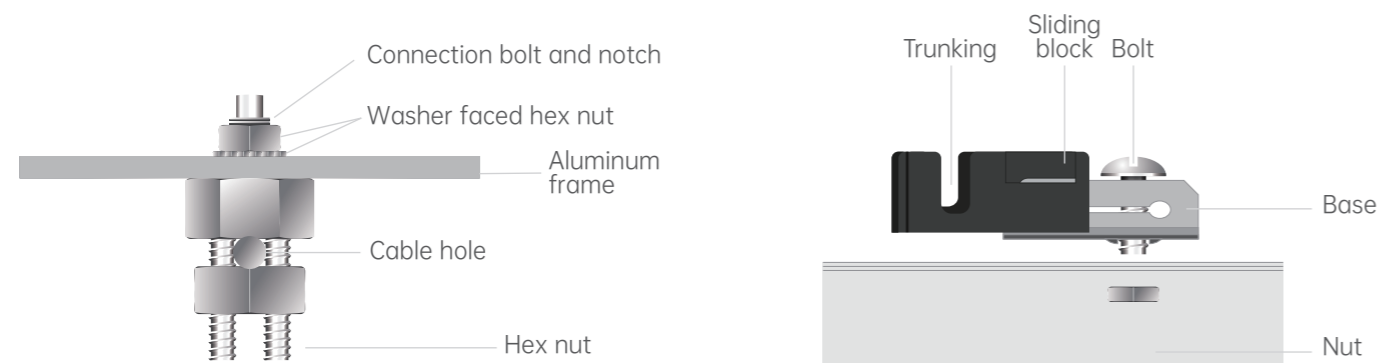

09 Maintenance of PV modules

PV modules shall be inspected and maintained on a regular basis, especially within the warranty period, which is an obligatory responsibility of the user. Any damage or other visible abnormalities of the PV module shall be reported to AIKO customer service(cs@aikosolar.com) upon discovery.

9.1 Cleaning

The power output of PV modules is related to incident light intensity and can be reduced by dust collection or other shadings. Dirt on PV modules must be cleaned up immediately.

The cleaning frequency depends on the degree of dirt collection. PV modules installed at an adequate tilt angle will allow rainwater to clean the PV module surfaces, thereby reducing the cleaning frequency.

We recommend cleaning the glass surface of the PV module with a clear water-netted sponge. Do not clean PV modules with a detergent containing acid or alkali. Do not clean PV modules with a hair brush or other rough surface tools.

We recommend cleaning PV modules in the early morning or late afternoon or other periods of time when the light is weak and the PV module temperature is comparatively lower.

Method A: High Pressure Water Cleaning

Water quality requirement

- PH:6-8
- Water hardness - calcium carbonate concentration: <600mg/L;
- Recommended use of soft water cleaning;
- Recommended maximum water pressure is 4MPa(40bar)

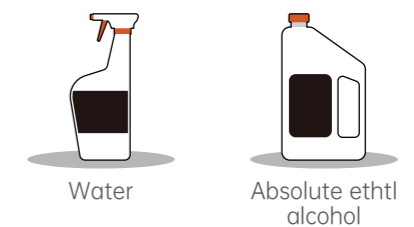

Method B: Wet Test Cleaning

- If there is too much stain on the surface of the PV module, it's recommended to carefully use an insulating brush, sponge or other soft cleaning tool.

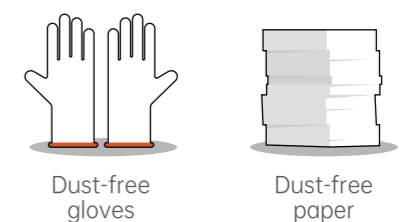

- Ensure that any brushes or agitating tools are made of insulating material to minimize the risk of electric shock and that they do not scratch the glass or aluminum frame.

- For oil stains, it's recommended to use an environmentally friendly, non-corrosive cleaning cleaner.

Method C: Robot Cleaning

- If the cleaning robot is used for dry cleaning, the brush material is required to be soft plastic, so that the glass surface and aluminum alloy frame of the PV module will not be scratched during and after cleaning. The weight of the cleaning robot should not be more than 40kg, the PV module damage and power degradation caused by improper cleaning with the cleaning robot are not covered by the warranty of AIKO.

9.2 Visual Checks of the PV Modules

Visually checks for visual defects on modules, such as:

- Whether the PV module glass is broken
- Whether the junction box is damaged or the cable is broken
- Whether the PV module is shaded by foreign matter or shadows
- Check whether the bolts fixing the PV module to the racking are loose or corroded and adjust or replace them if necessary
- Check whether the PV modules are well-grounded

9.3 Checks of Connectors and Cables

It is recommended to perform preventive examinations every six months, such as:

- Whether the connectors are properly sealed and the cables are properly fastened
- Whether the sealant of the junction box is cracked

9.4 AIKO Technical Support

In order to request Technical Support:

- Collect evidences of the issue as (a) photos and (b) measurements.
- Be prepared to show the purchase invoice and module serial number.
- Contact your Installer.



Neostar

Clamping Zone Extension

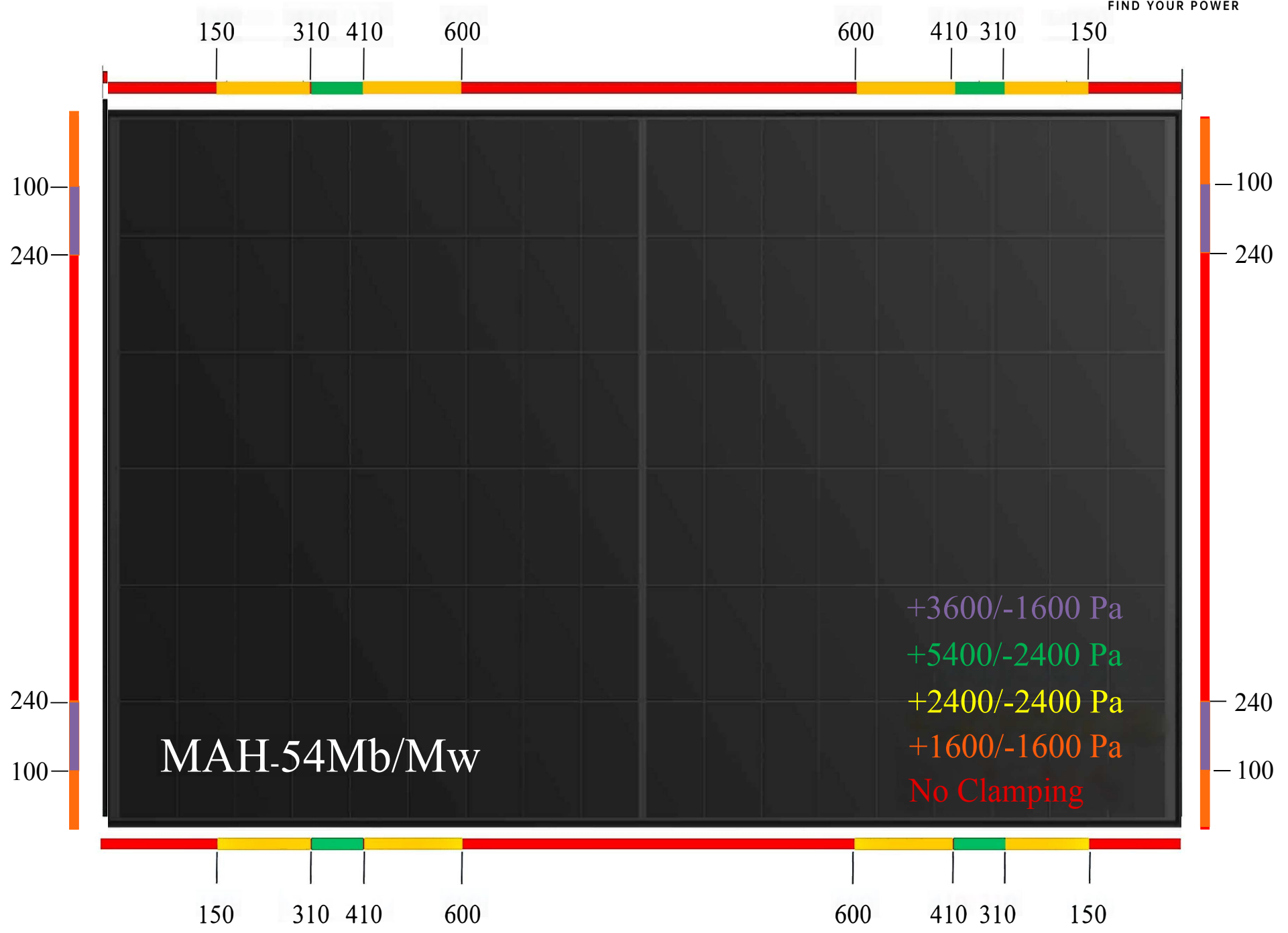

This load graph present when the purlin cross the long side/short side, number means the distance between the edge of clamp to the frame. Unit:mm

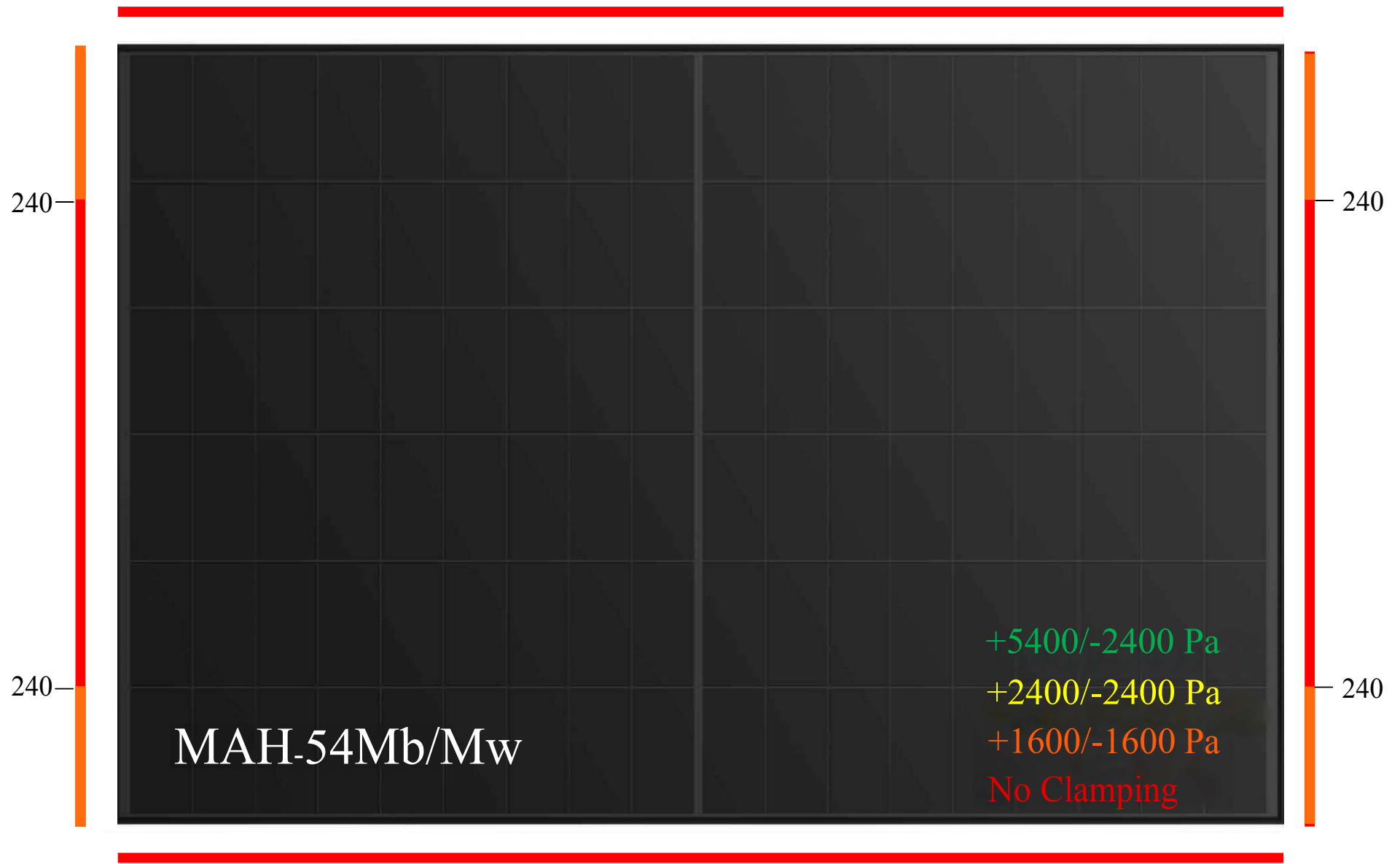

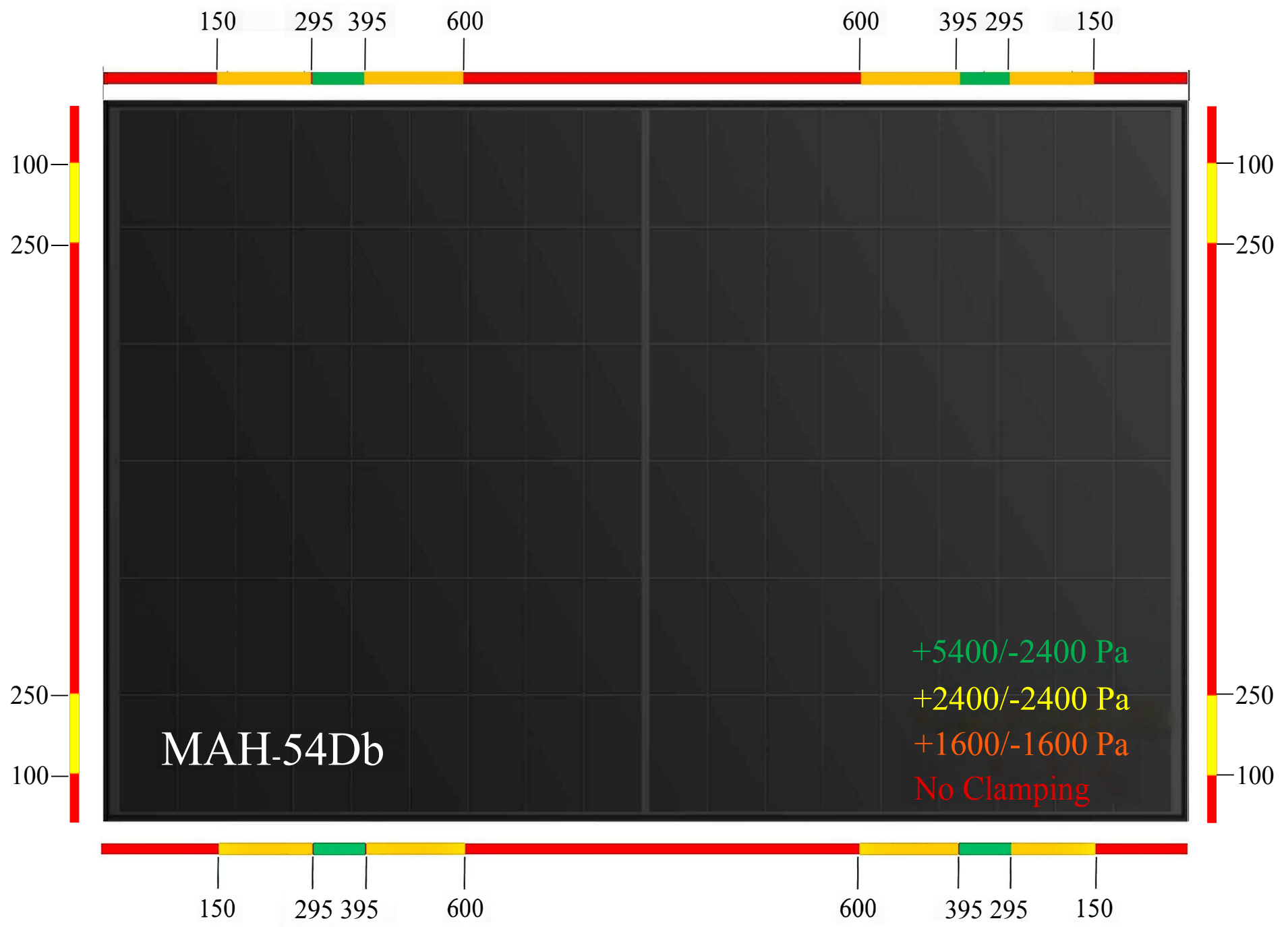

This load graph present when the purlin cross the long side/short side, number means the distance between the edge of clamp to the frame. Unit:mm

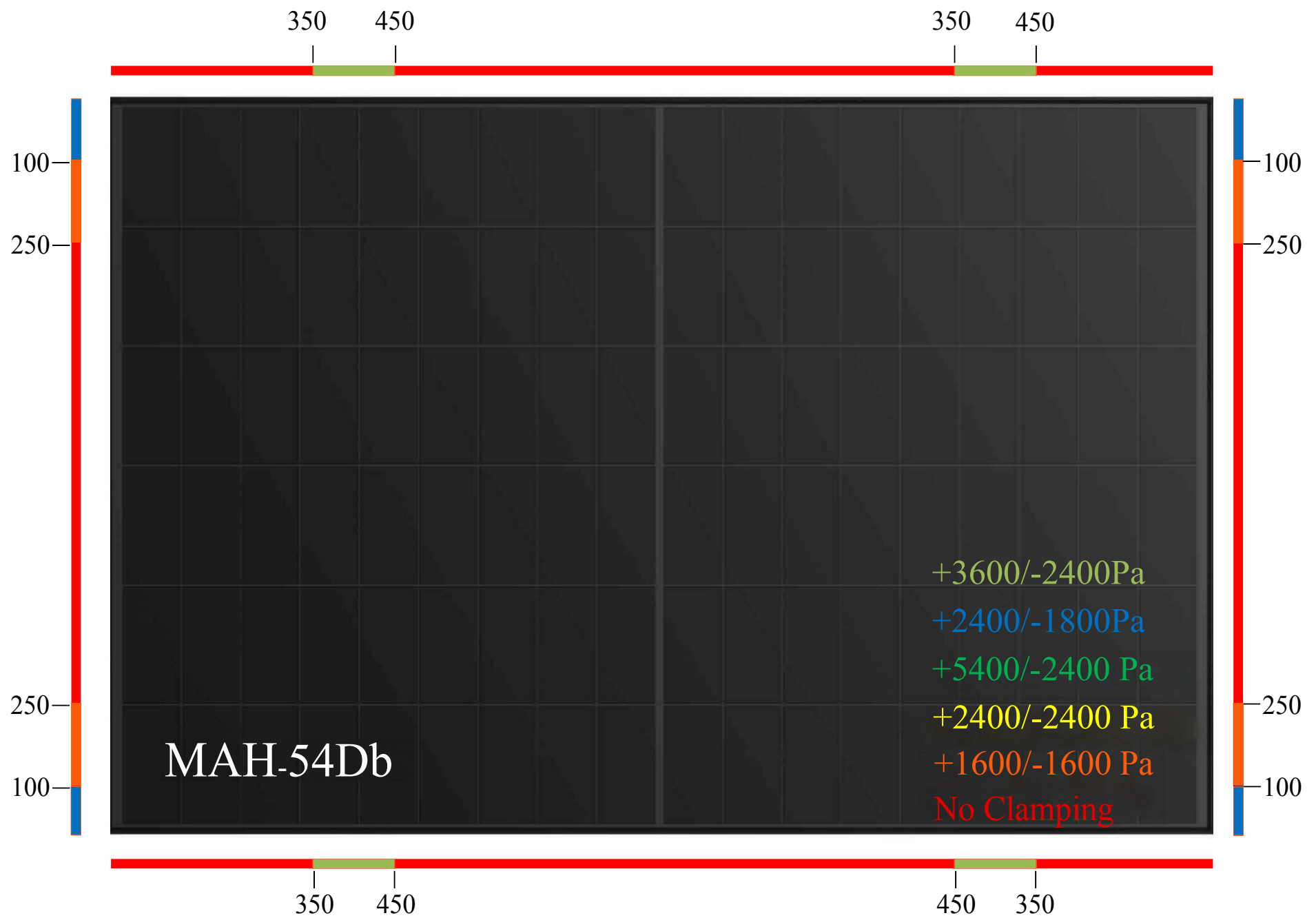

This load graph present when the purlin overlap the long side/short side, number means the distance between the edge of clamp to the frame. Unit:mm



NEOSTAR 60 CELLS

Extended Clamping Zone

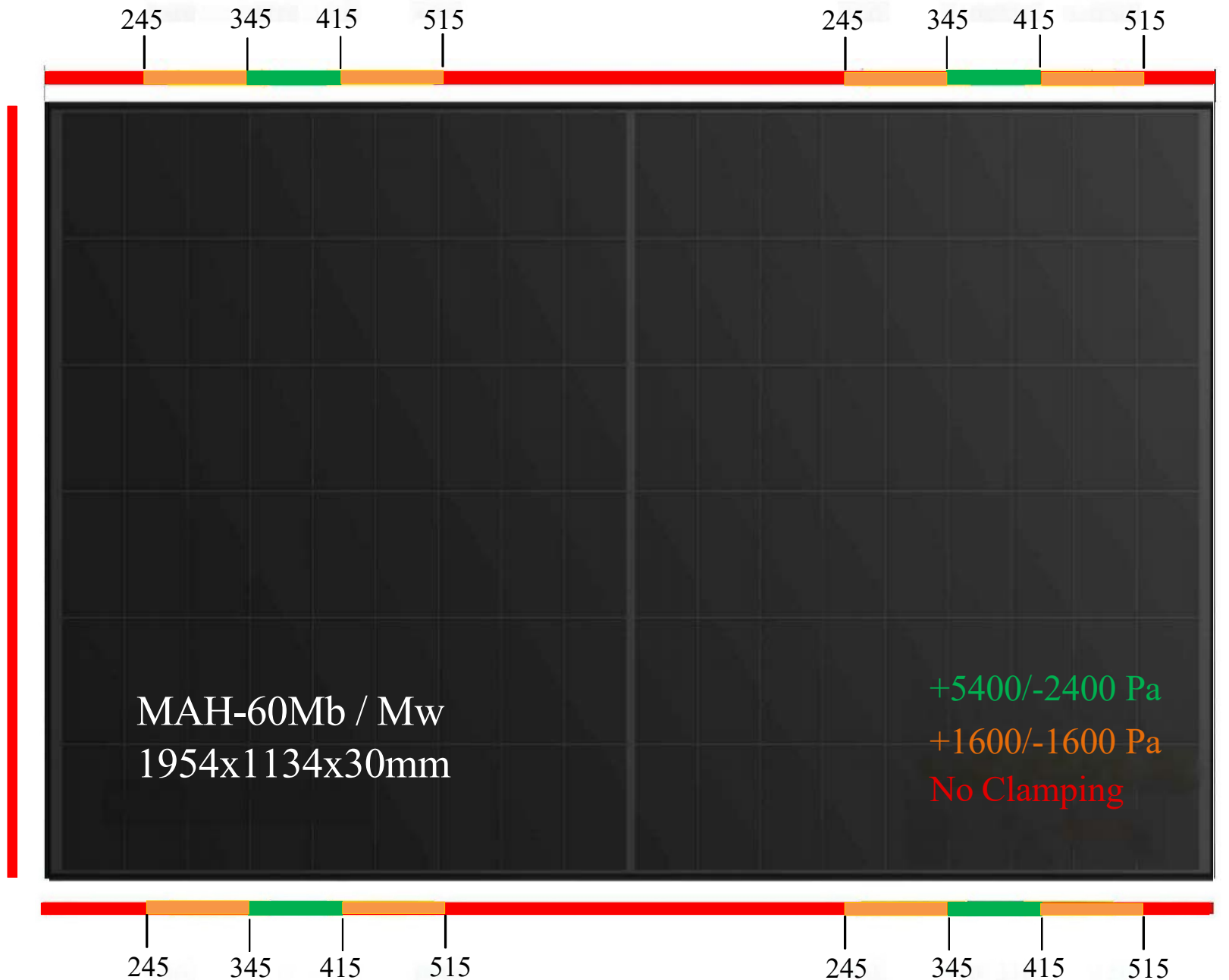

This load graph present when the purlin cross the long side/short side, number means the distance between the edge of clamp to the frame. Unit:mm



Comet

Clamping Zone Extension

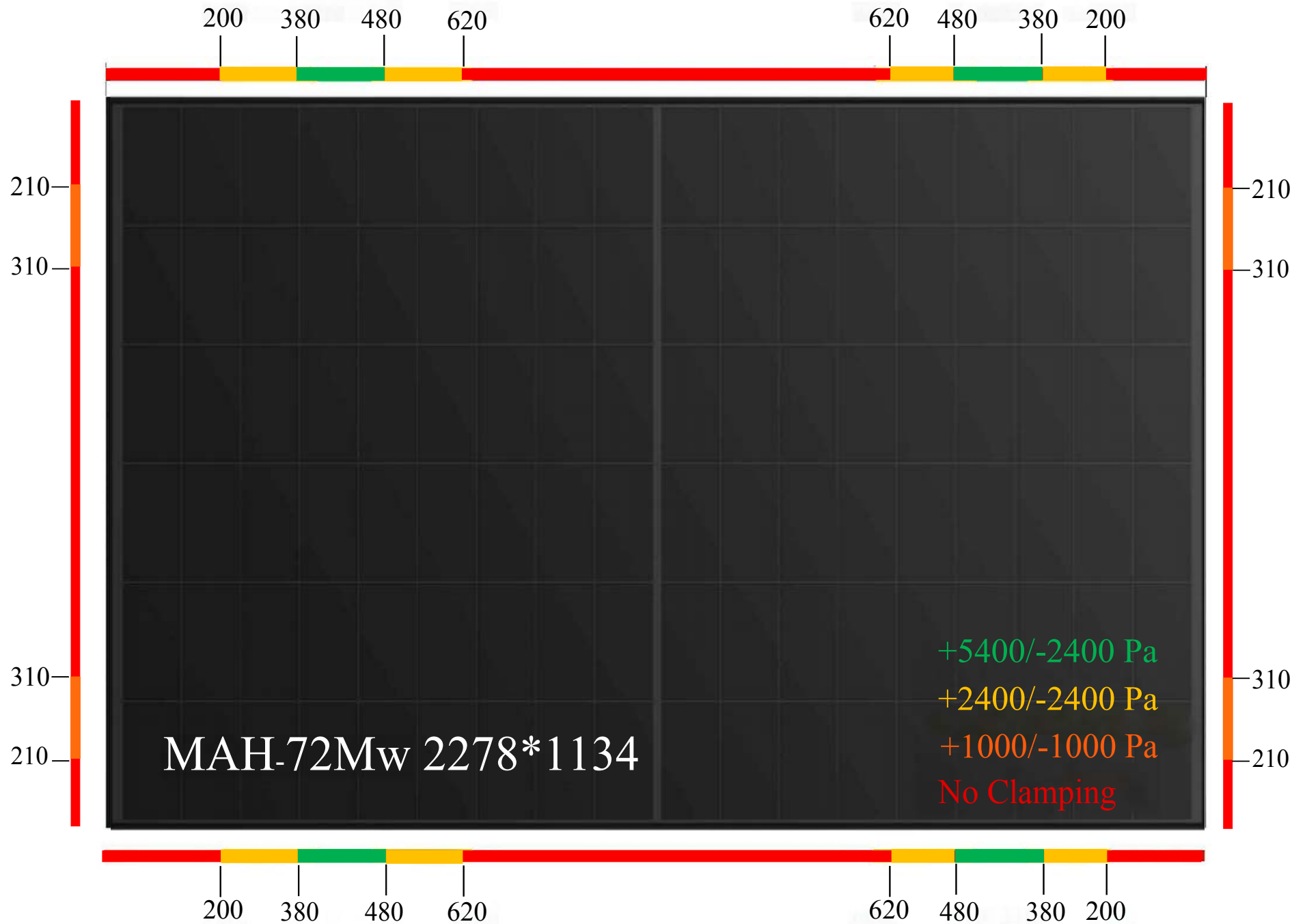

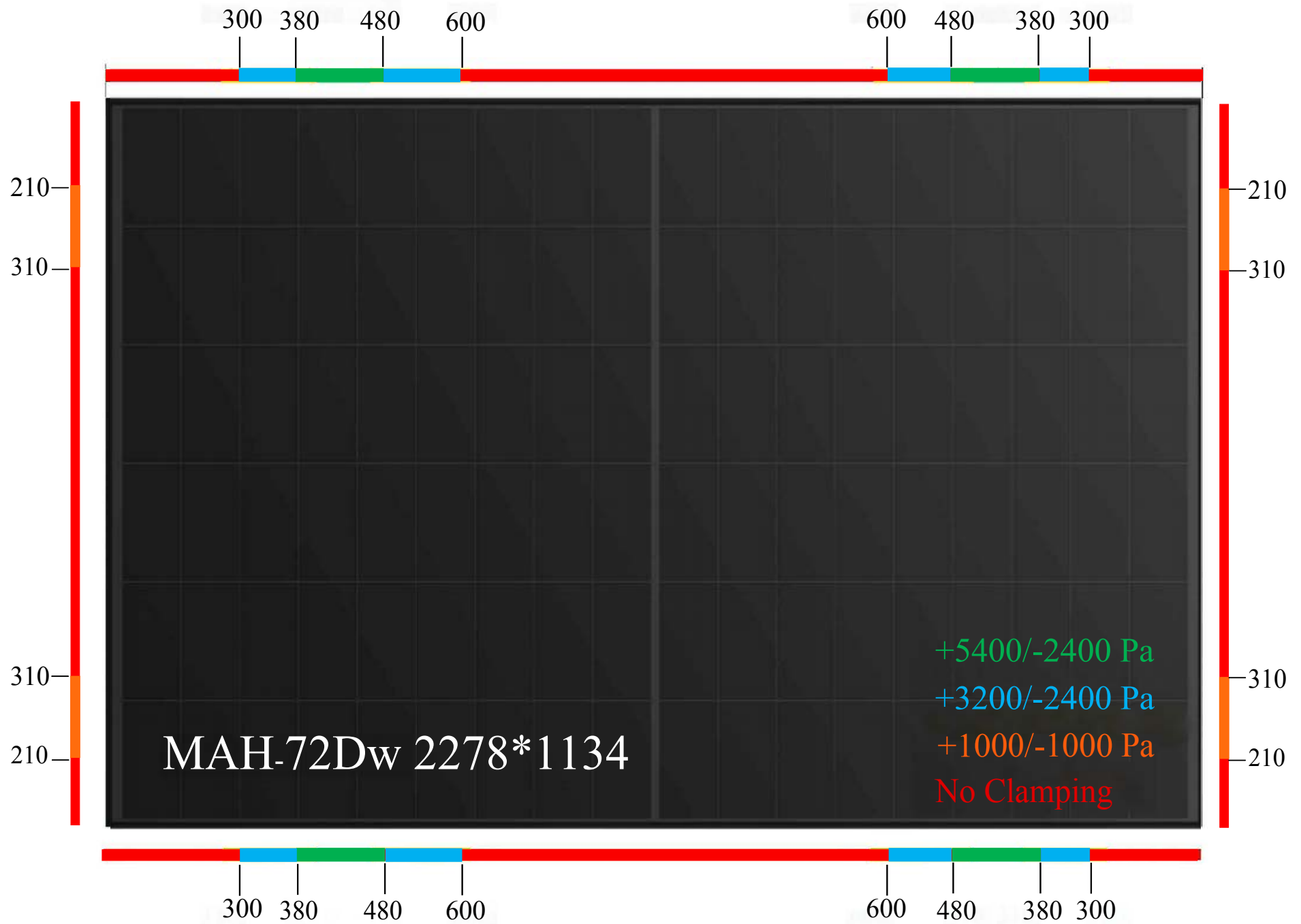

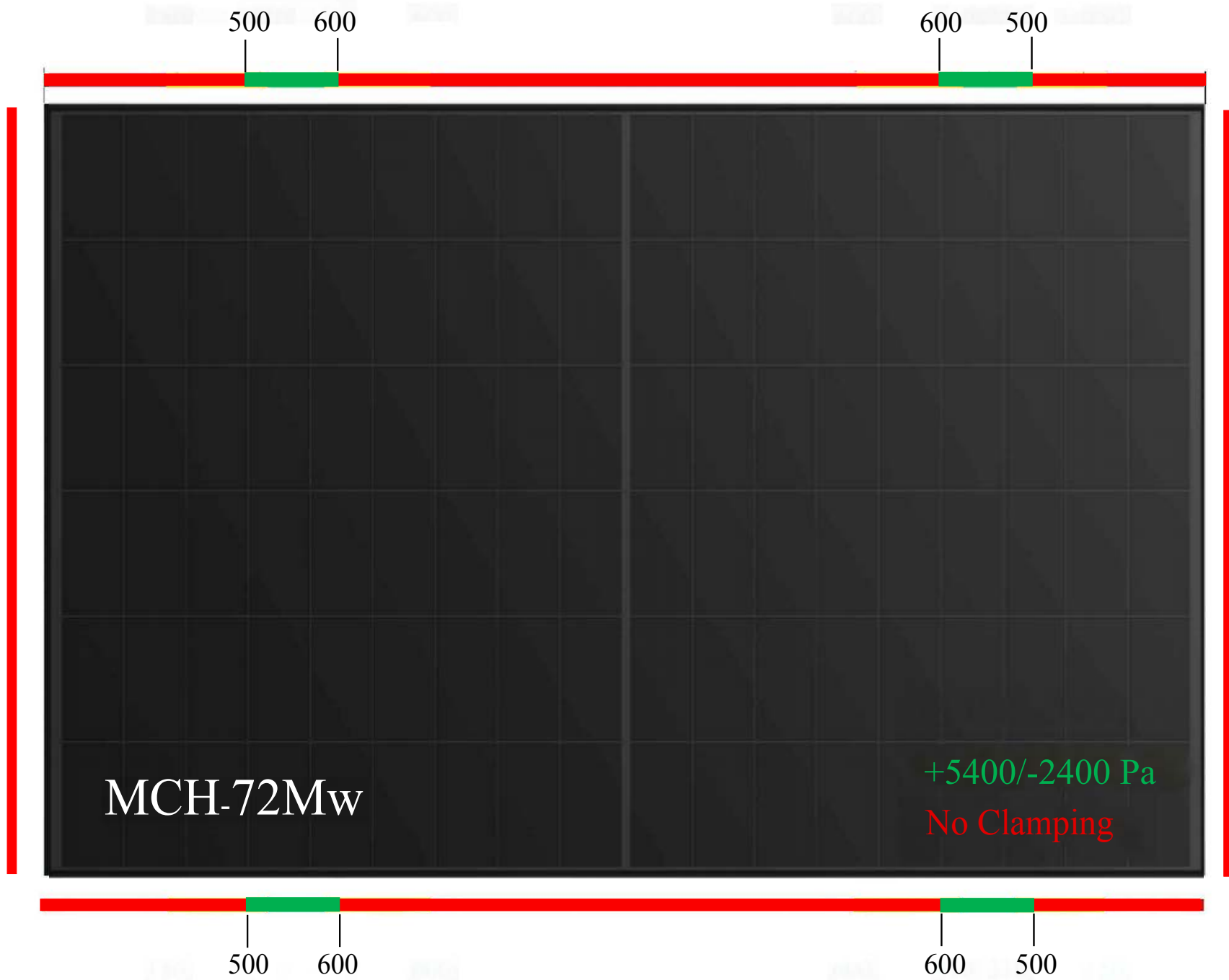

This load graph present when the purlin cross the long side/short side, number means the distance between the edge of clamp to the frame. Unit:mm



COMET 2U

Clamping Zone Extension

420 470 620 720

720 620 470 420

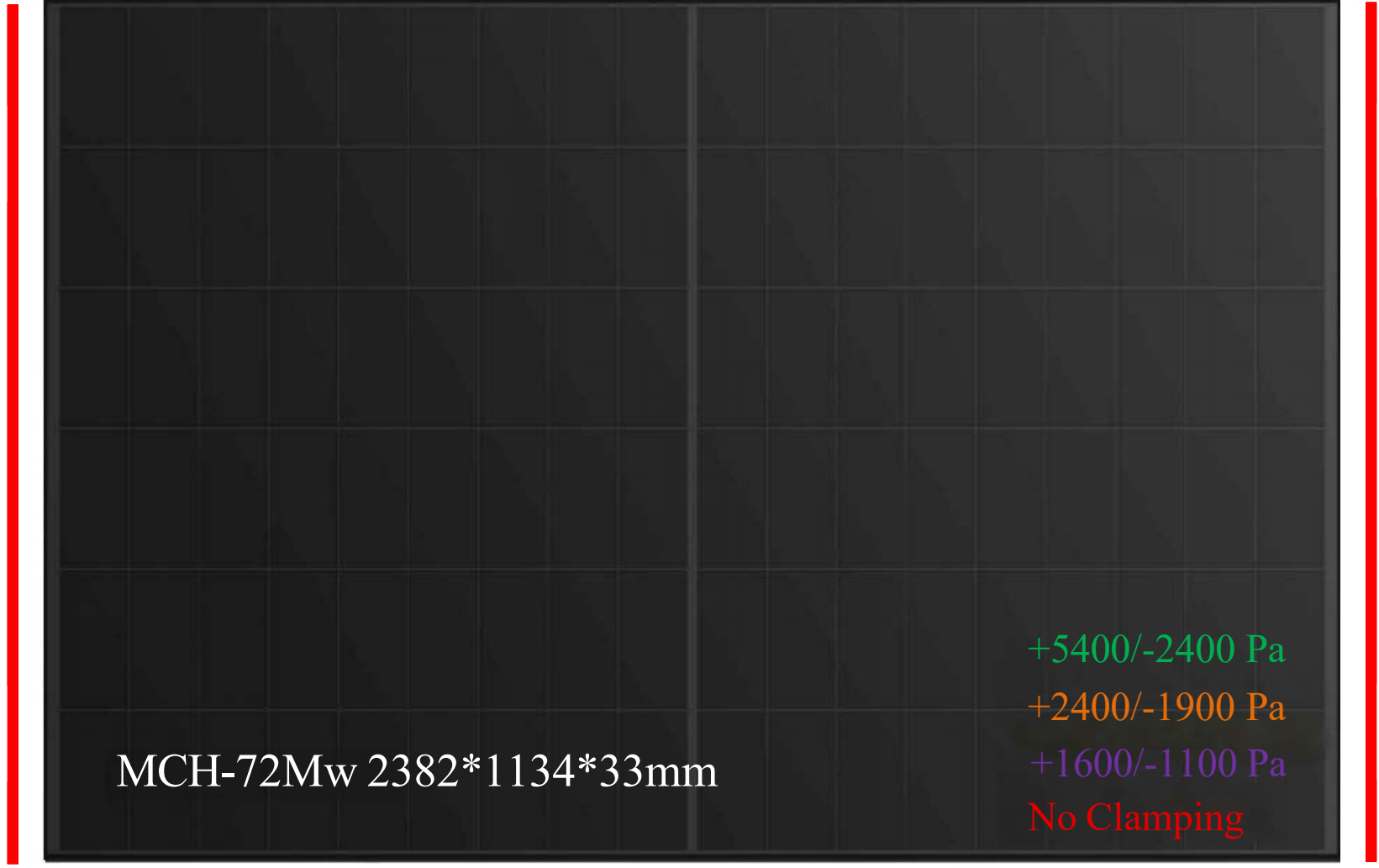

MCH-72Mw 2382*1134*33mm

+5400/-2400 Pa
+2400/-1900 Pa
+1600/-1100 Pa
No Clamping

420 470 620 720

720 620 470 420





Stellar

Clamping Zone Extension

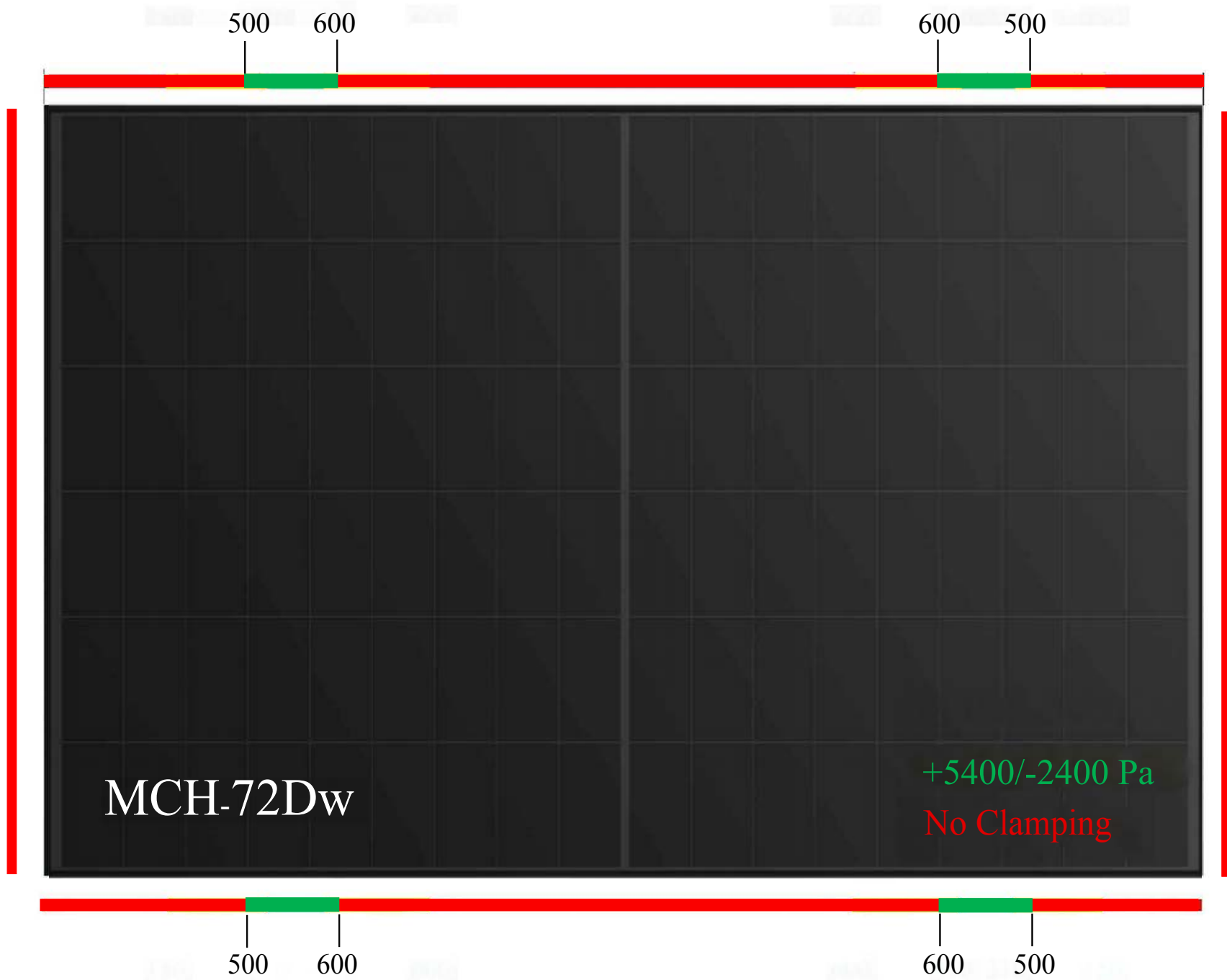

MCH-72Dw

+5400/-2400 Pa

No Clamping



NEBULAR 54 CELLS – LIGHTWEIGHT MODULE

Extended Clamping Zone

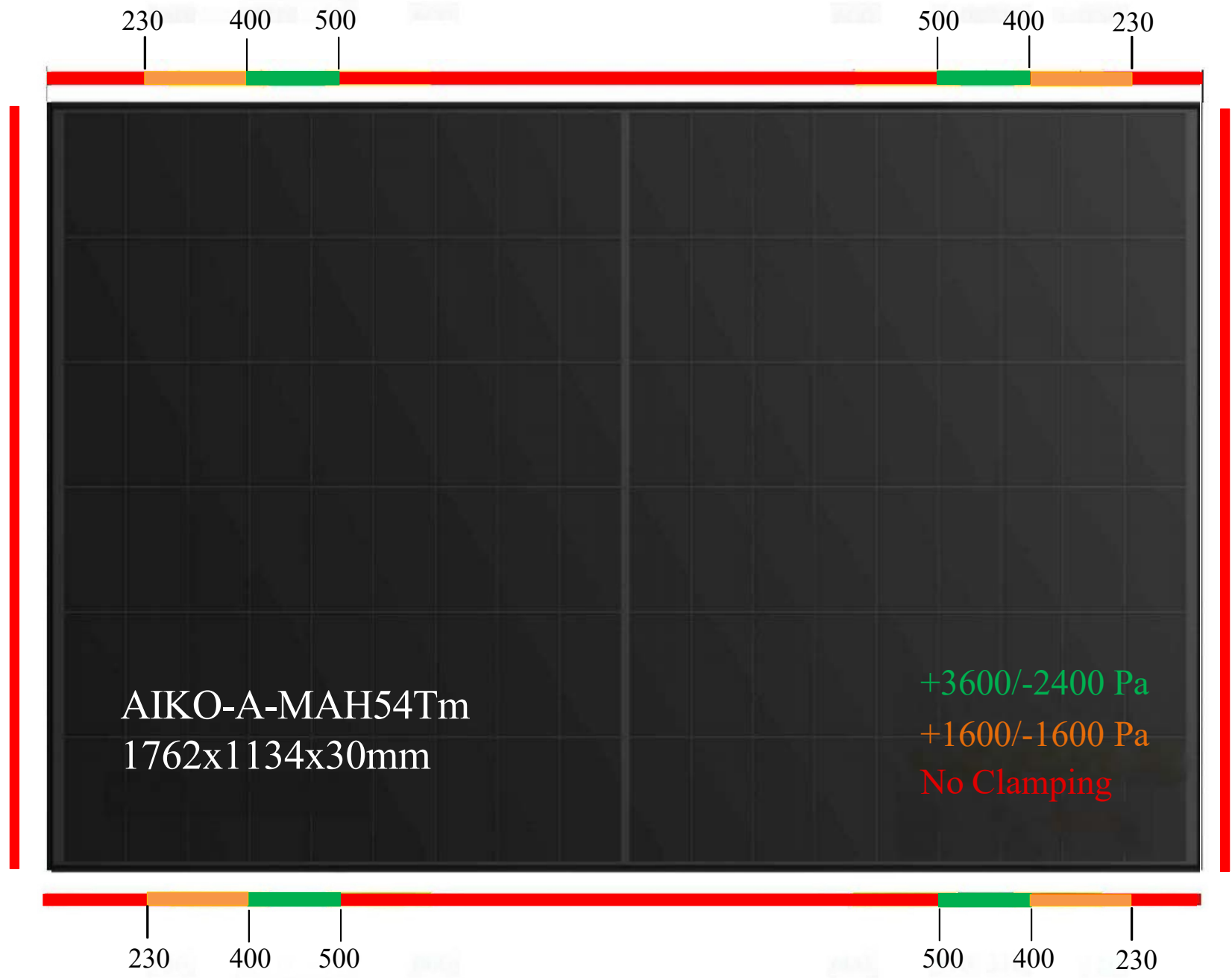

This load graph present when the purlin cross the long side/short side, number means the distance between the edge of clamp to the frame. Unit:mm